



FLAT SHOWER WALL
 SIDE CONTOUR SHOWER WALL
 CORNER CONTOUR SHOWER WALL
 FLAT BATH WALL

DURACRYL WALL

INSTALLATION GUIDE

INDEX

| | PAGES |
|--|-------|
| Introduction | 1 |
| Tools and materials | 1 - 2 |
| Construction requirements - timber frame | 3 |
| Duracryl wall installation | 3- 6 |
| Cleaning instructions | 8 |

INTRODUCTION.

IMPORTANT

Read all instructions carefully before starting the installation to ensure the best possible results. It is the responsibility of the installer to ensure that the installation complies with council and local authority bylaws.

Instructions, drawings, and diagrams contained in this manual present information available at the time of printing. Although every attempt has been made to keep them up-to-date, Kohler Company reserves the right to implement product changes without further notice.

TOOLS AND MATERIALS REQUIRED.

| | |
|------------|------------------------------|
| Level | Hole saw |
| Tape | Fine toothed saw |
| Pencil | Jig saw (fine toothed blade) |
| Ruler | Caulking gun |
| Drill | Construction adhesive |
| Drill bits | Sealant. |

IMPORTANT

Use only recommended sealants and adhesives, suitable on acrylic and acrylic capped ABS; unsuitable products may damage the duracryl surround.

TOOLS AND MATERIALS REQUIRED.

The recommended adhesive and sealant is:

Sika Shower Bond -to adhere the acrylic shower liner to the wall.

Usage:

- 3 cartridges for 2 sided wall liners
- 4 cartridges for 3 sided wall liners

Sika Silaflex NG (White) - to seal the acrylic shower liner to shower tray.

These are available in separate Adhesive and Sealants Packs.

For stockists phone 0800 100 382.

Each Pack contain enough adhesive and sealant for a complete white or metallic shower enclosure:

- **16520A-0** Adhesive & sealant combo pack - 2 sided shower & bath acrylic wall liner for **white** framed showers.
- **16521A-SHP** Adhesive & sealant combo pack - 2 sided shower acrylic wall liner for **metallic** framed showers.
- **16522A-0** Adhesive & sealant combo pack - 3 sided shower acrylic wall liner for **white** framed showers.
- **16523A-SHP** Adhesive & sealant combo pack - 3 sided shower acrylic wall liner for **metallic** framed showers.



CONSTRUCTION REQUIREMENTS - TIMBER FRAME

For shower, identify the type of installation required and construct timber frame in accordance with the dimensions detailed on the back of the tray carton.

Determine where the centre of the drain hole will be.

Where the drain is likely to coincide with a joist, ensure trimmers are used to create a space beneath the floor to accommodate an Easy Clean Trap or Hi Flow Waste.

Typical timber frame is shown on the right hand side.

For bath tub, timber frame detailed in the installation guide supplied with the product.

Fix wall lining to studs.

Wall lining must be double nailed or screwed at 200 mm centres minimum.

Wall lining surface must be flat and plumb, the corner must be square.

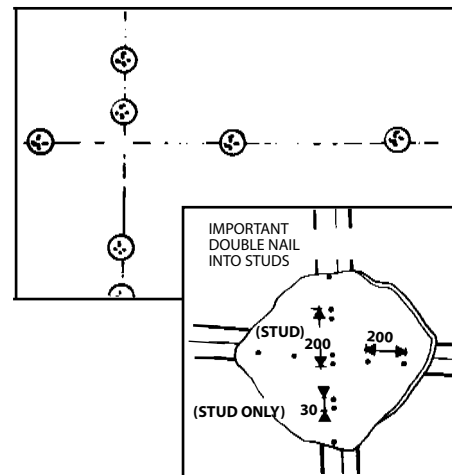
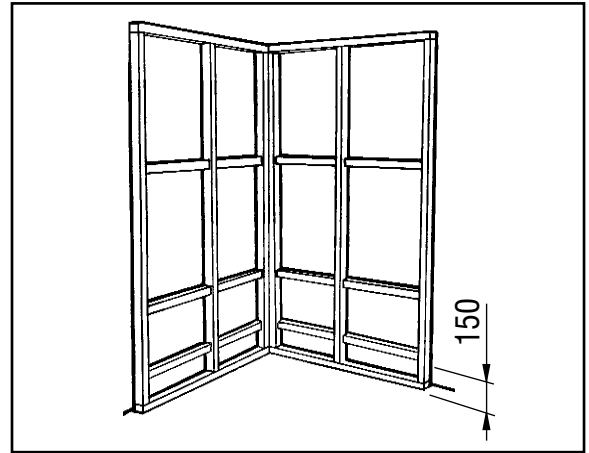

DURACRYL WALL INSTALLATION

DRILLING AND CUTTING DURACRYL

DRILLING: Small holes can be drilled with a twist drill, but the cutting edge **MUST** be backed off with an oil stone (the sharp edge dulled). Large holes must be drilled with a hole saw. Maximum drill size : 12 mm. Drill speeds : 6 mm x 1800 RPM ; 12 mm x 900 RPM.

CUTTING: If for any reason the Duracryl requires cutting, use a fine tooth hacksaw and proceed with caution.

Edges can be smoothed with a second-cut file and medium-fine sandpaper. If the surface of the Duracryl should happen to be damaged, it can be restored by polishing with an abrasive cleaner such as Meguiars Mirror Glaze 28 All metal polish or 3M Marine "one step" painted aluminium cleaner and wax.

TOOLS REQUIRED

- Tape measure
- Soft Pencil
- Drill
- Caulking gun
- Hole saw
- Drill bits
- Fine toothed saw
- Spirit level
- Jig saw (fine toothed blade)

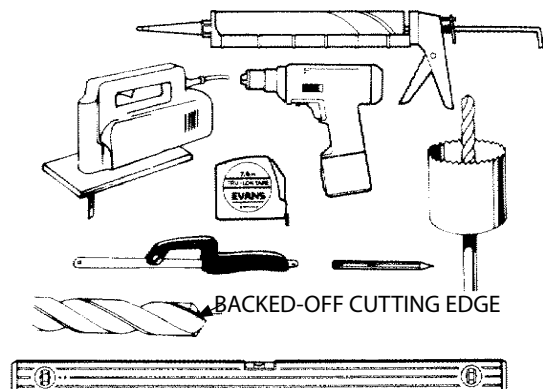

SHOWER WALL INSTALLATION cont...

DURACRYL WALL INSTALLATION

Ensure shower tray or bath tub are installed correctly, as detailed in the installation guide supplied with the product. Peel back protective film of the tiling bead of shower tray or bath tub, in order to make a water tight seal possible.

Ensure the surface of tray or bath tub is protected during installation, and no debris can get onto the waste hole.

For bath tub use a drop cloth.

For shower tray, select appropriate size, then cut base protector from back of shower tray carton. Place it in shower tray.

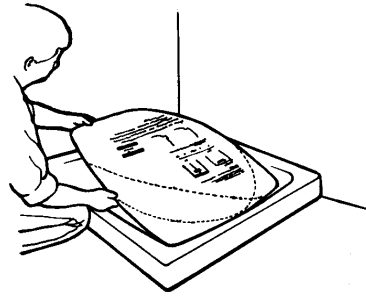

Mark and drill holes required for outlet fittings.

NOTE: Drilling and cutting instructions appear on the previous page.

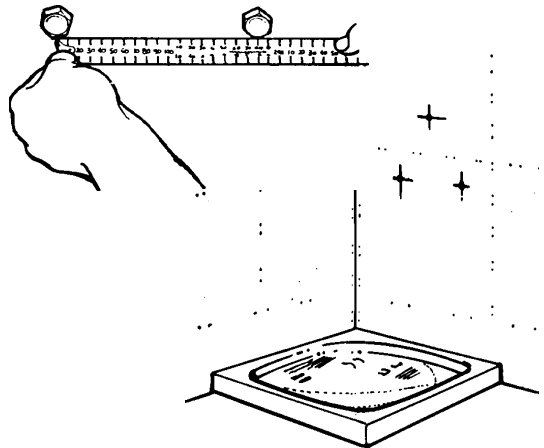

Position wall in place. Check fit to ensure wall fits squarely into corner. Tape edges to hold into position.

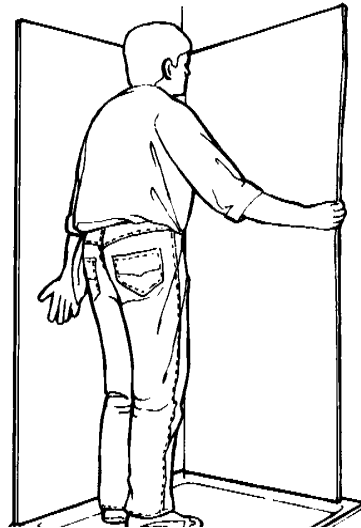

Where necessary (bath tub) notch the edge of the wall to fit over the tiling bead as shown on the right hand side diagram.

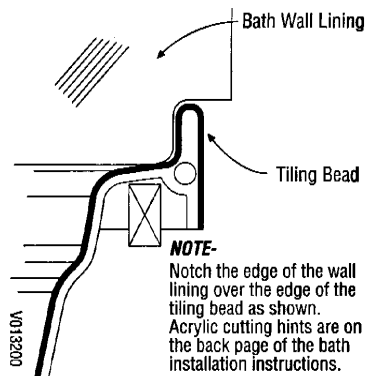

SHOWER WALL INSTALLATION cont...

With a soft pencil, mark around the perimeter of the wall. This will be the basis for marking the glue pattern.

Before marking, make sure wall is pressed firmly into corner .

Carefully **measure and mark pattern** on wall board surface as shown on the right. **Do not apply the adhesive at this stage.**

NOTE: Measurements from edges, top and base. All dimensions below are in millimeters.

Refer to diagram on the right hand side for adhesive pattern for:

- Flat shower wall
- Side contour shower wall
- Flat bath wall

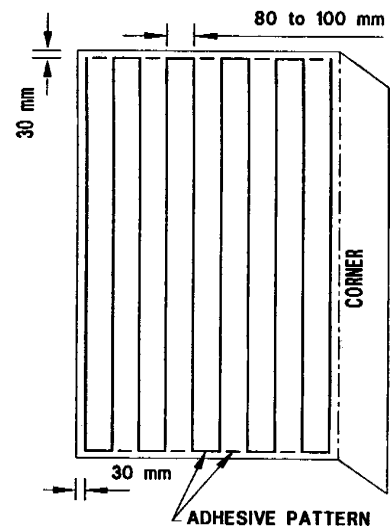
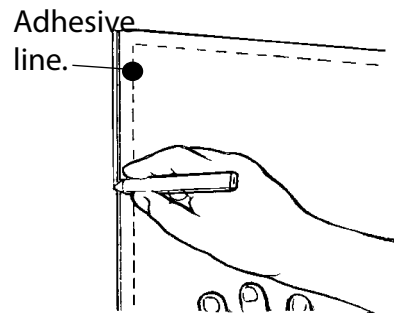

For corner contour shower wall pattern must be marked on both wall board and duracryl shower surround.

Refer to diagrams on the right hand side for both patterns.

At this stage it is essential that the back side of the duracryl wall and the surface of the wall board are wiped clean with a damp cloth. This will ensure that all dust is removed from both surfaces and provide a clean surface for the adhesive. Allow both surfaces to dry before adhesive application.

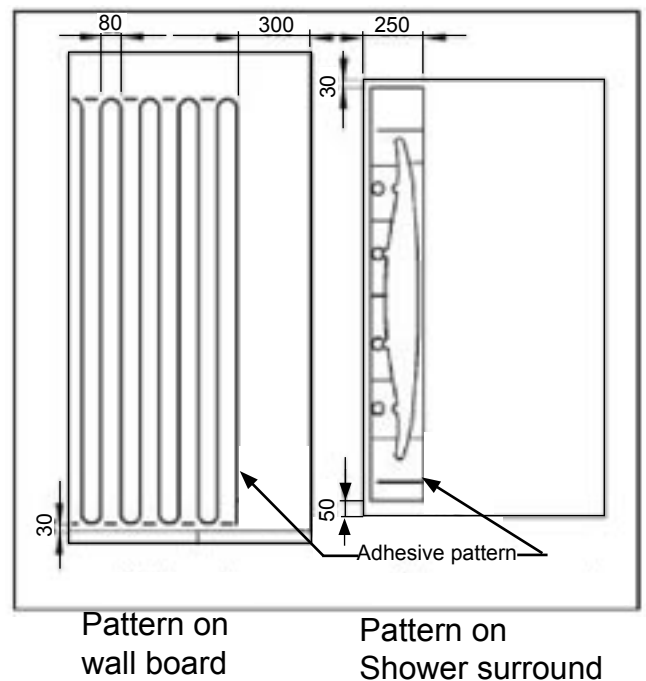

SHOWER WALL INSTALLATION cont...

Prepare sealant and adhesive cartridges.
Cut nozzle on sealant and adhesive cartridges as shown in the picture on the right.
Pierce protective foil inside adhesive cartridge.

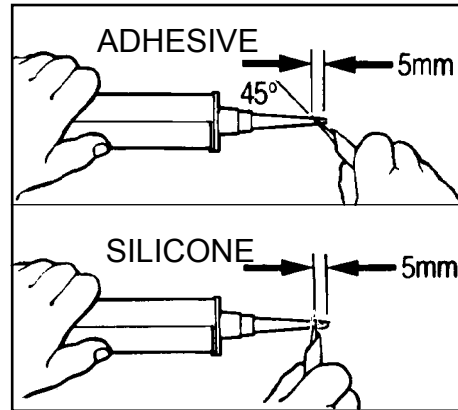

CAUTION

Do not apply adhesive below 5°C.
Temperatures below this point
will require adhesive to be warmed up
to assist with adhesive flow and application.
Use only in ventilated areas.

Apply sealant to shower tray or bath first as shown on the right hand side diagram.
Ensure the protective film has been peeled back from tiling bead of base before applying sealant. Leave the rest of the shower tray or bath still covered by the plastic film, to protect it during installation.
Apply a bead of sealant for 50 mm from both front corners at base of upstand as shown.
Apply a second bead to full length at top of upstand.

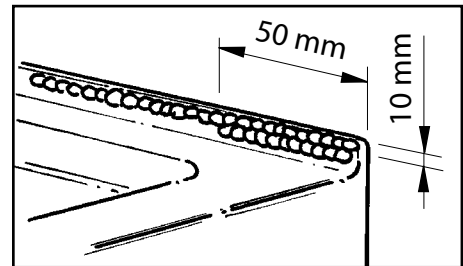

Apply adhesive to wall board.
Do not use on previously painted, sealed or ceramic walls.
Use only on the following substrate:

- Plaster Board
- Fibre cement
- Villaboard.

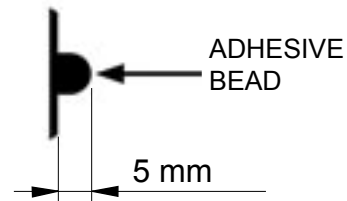

Follow the pattern marked. Start at top working your way down.
Apply vertical pattern first then fill in horizontal lines.

For corner contour shower wall remember to apply the adhesive on the acrylic wall as show on previous page.

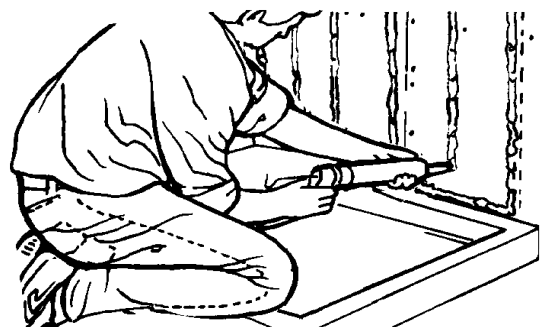

SHOWER WALL INSTALLATION cont...

To install the wall follow adhesive manufacturer instructions.

As a general rule, place wall into position. Press firmly back into corner to ensure that the wall makes full contact with corner along its entire length.

Press into corners first, then press toward edges. Use a soft clean cloth to press firmly and remove any rippling along glue lines. Check and repress if necessary.

Remove plastic film.

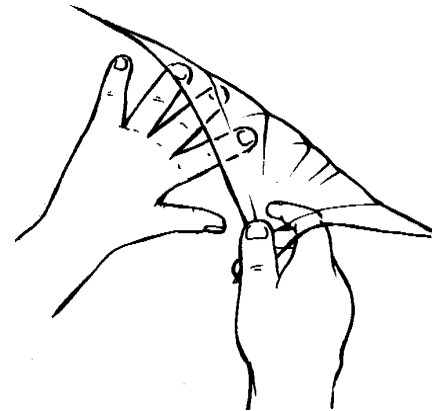
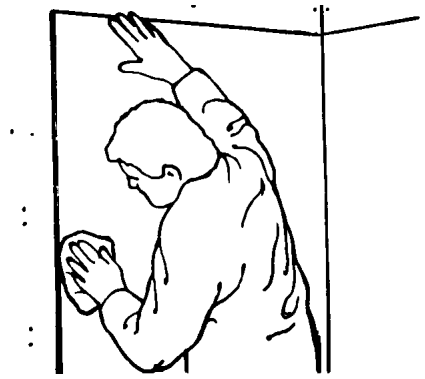

CLEANING INSTRUCTIONS

Use non abrasive soap and water when possible.

In addition you may safely use:

- Mr Muscle Shower Clean
- Jif Powerspray.

Avoid:

- harsh chemicals and disinfectants.
- abrasive cleaners
- solvent based cleaners
- acid or alkaline cleaners
- products containing ammonia or peroxides.

Wipe out the unit after each use to prevent build-up of soap and scum.

Always read the label instructions on any cleaner carefully before applying it to the surface.



IMPORTANT

Read the Care and Maintenance label on the wall and leave it in place for the end user.

KOHLER®

CALL US FOR HELP

NEW ZEALAND

KOHLER NZ Ltd.

Ph 0800 100 382

Fax 0800 664 488

www.inglefield.co.nz