



FLAT SHOWER WALL
SIDE CONTOUR SHOWER WALL
CORNER CONTOUR SHOWER WALL
FLAT BATH WALL

DURACRYL WALL

INSTALLATION GUIDE

INDEX

	PAGES
Introduction	1
Tools and materials	1
Construction requirements - timber frame	2
Duracryl wall installation	2- 6
Cleaning instructions	7

INTRODUCTION

IMPORTANT

Read all instructions carefully before starting the installation to ensure the best possible results. It is the responsibility of the installer to ensure that the installation complies with council and local authority bylaws.

Instructions, drawings, and diagrams contained in this manual present information available at the time of printing. Although every attempt has been made to keep them up-to-date, Kohler Company reserves the right to implement product changes without further notice.

TOOLS AND MATERIALS REQUIRED

Level	Hole saw
Tape	Fine toothed saw
Pencil	Jig saw (fine toothed blade)
Ruler	Caulking gun
Drill	Construction adhesive
Drill bits	Sealant.

IMPORTANT

Use only quality sealants and adhesives suitable on acrylic and acrylic capped ABS. Unsuitable products may damage the Duracryl surround. For installation, observe sealant and adhesive manufacturer's instructions.

CONSTRUCTION REQUIREMENTS - TIMBER FRAME

For a shower installation, identify the type of installation required and construct the timber frame in accordance with the dimensions detailed on the back of the tray carton.

Determine where the centre of the drain hole will be.

Where the drain is likely to coincide with a joist, ensure trimmers are used to create a space beneath the floor to accommodate an Easy Clean Trap or Hi Flow Waste.

A typical timber frame is shown on the right. For bath tubs, the timber frame is detailed in the installation guide supplied with the product.

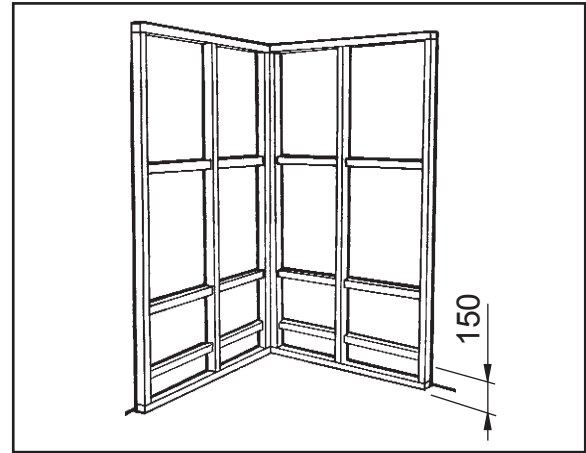

Fix wall lining to studs.

Wall lining must be double nailed or screwed at no less than 200mm centres.

The wall lining surface must be flat and plumb, the corner must be square.

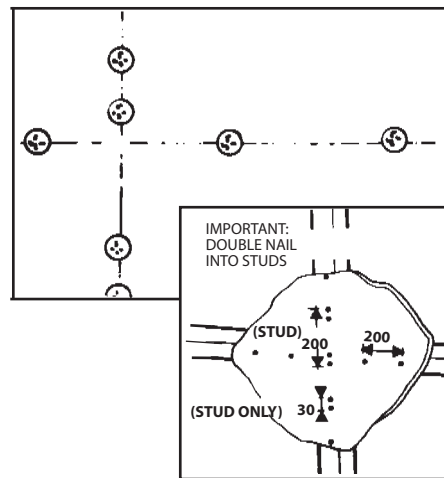

DURACRYL WALL INSTALLATION

DRILLING AND CUTTING DURACRYL

DRILLING: Small holes can be drilled with a twist drill, but the cutting edge **MUST** be backed off with an oil stone (the sharp edge dulled). Large holes must be drilled with a hole saw. Maximum drill size: 12 mm. Drill speeds: 6 mm x 1800 RPM; 12 mm x 900 RPM.

CUTTING: If for any reason the Duracryl requires cutting, use a fine tooth hacksaw and proceed with caution.

Edges can be smoothed with a second-cut file and medium-fine sandpaper. If the surface of the Duracryl should happen to be damaged, it can be restored by polishing with an abrasive cleaner such as Meguiar's Mirror Glaze 28 All metal polish or 3M Marine "One Step" painted aluminium cleaner and wax.

TOOLS REQUIRED

- Tape measure
- Soft Pencil
- Drill
- Caulking gun
- Hole saw
- Drill bits
- Fine toothed saw
- Spirit level
- Jig saw (fine toothed blade)

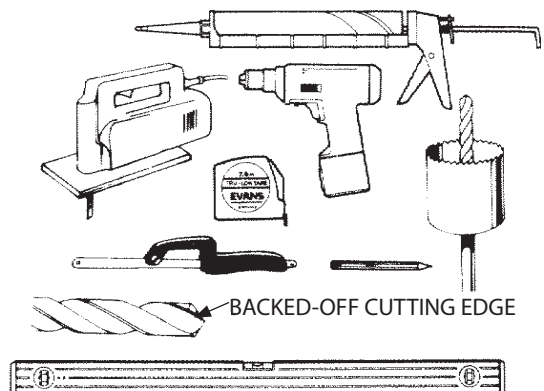

SHOWER WALL INSTALLATION cont...

DURACRYL WALL INSTALLATION

Ensure shower tray or bath tub is installed correctly, as detailed in the installation guide supplied with the product. Peel back the protective film of the tiling bead of shower tray or bath tub, in order to make a water tight seal possible.

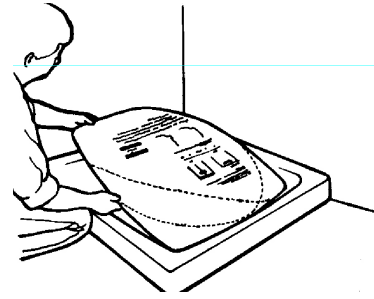

Ensure the surface of tray or bath tub is protected during installation, and no debris can get onto the waste hole. For a bath tub: use a drop cloth. For a shower tray: select appropriate size, then cut base protector from back of shower tray carton. Place it in shower tray.

Mark and drill holes required for outlet fittings.

NOTE: Drilling and cutting instructions appear on the previous page.

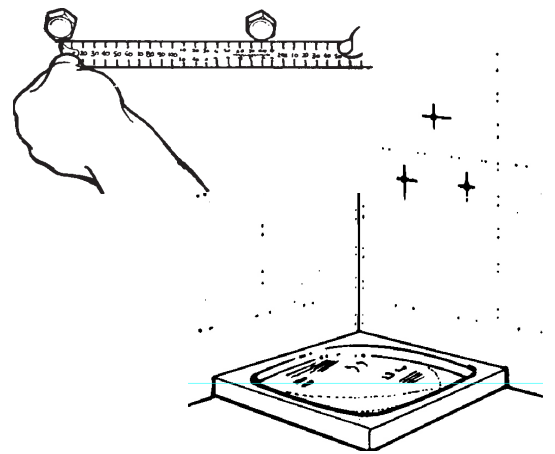

Position wall in place. Check fit to ensure wall fits squarely into corner. Tape edges to hold into position.

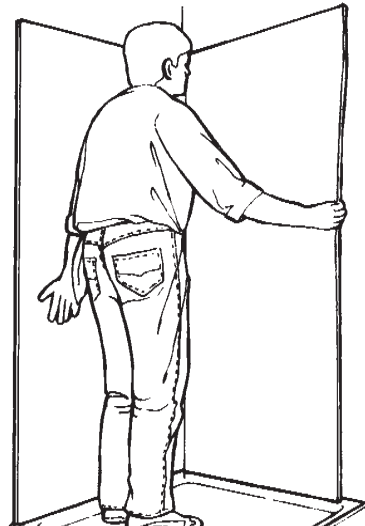

Where necessary (bath tub) notch the edge of the wall to fit over the tiling bead as shown on the right hand side diagram.

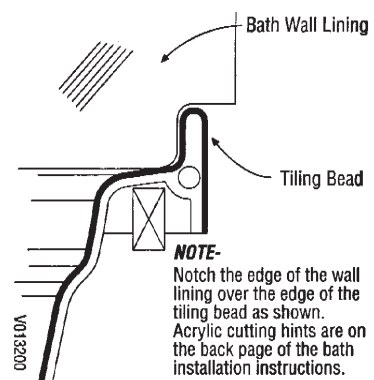

SHOWER WALL INSTALLATION cont...

With a soft pencil, mark around the perimeter of the wall. This will be the basis for marking the glue pattern.

Before marking, make sure wall is pressed firmly into corner .

Carefully **measure and mark pattern** on wall board surface as shown on the right. **Do not apply the adhesive at this stage.**

NOTE: Measurements from edges, top and base. All dimensions below are in millimeters.

Refer to diagram on the right hand side for adhesive pattern for:

- Flat shower wall
- Side contour shower wall
- Flat bath wall

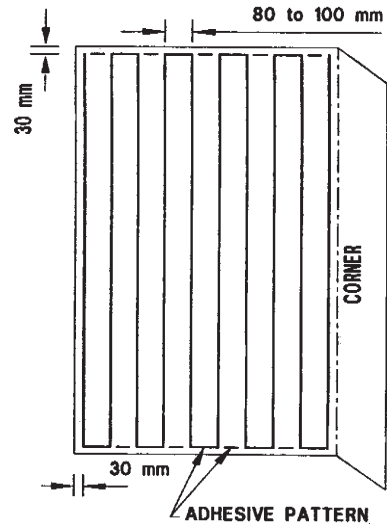
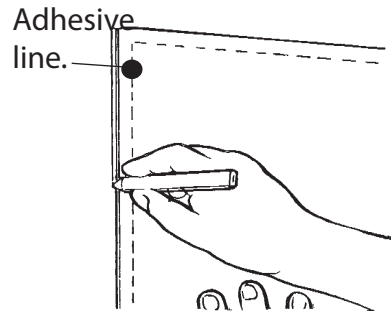

For corner contour shower walls, the pattern must be marked on both the wall board and Duracryl shower surround.

Refer to diagrams on the right hand side for both patterns.

At this stage it is essential that the back side of the Duracryl wall and the surface of the wall board are wiped clean with a damp cloth. This will ensure that all dust is removed from both surfaces and provide a clean surface for the adhesive. Allow both surfaces to dry before adhesive application.

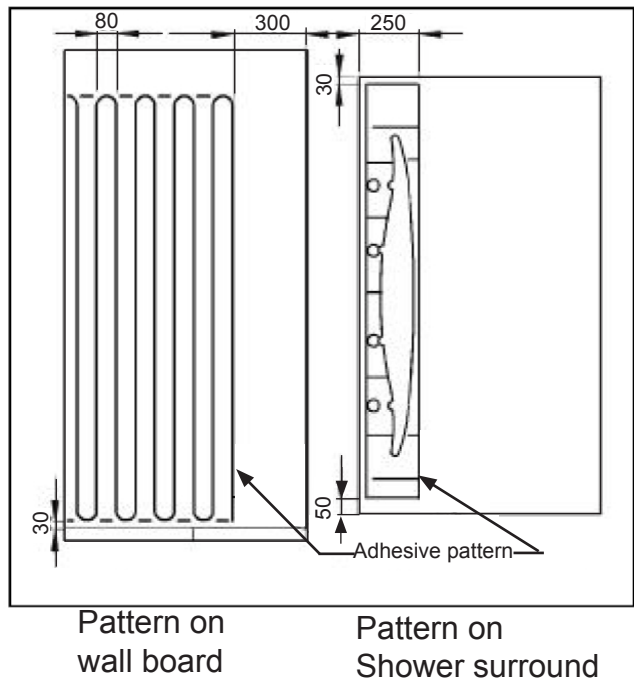

SHOWER WALL INSTALLATION cont...

Refer sealant and adhesive manufacturer instructions.

Prepare sealant and adhesive cartridges.
Cut nozzle on sealant and adhesive cartridges as shown in the picture on the right.

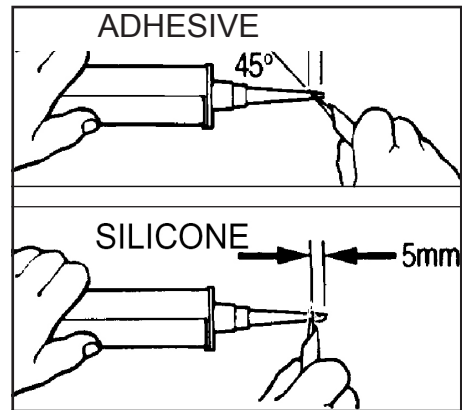

CAUTION

Do not apply adhesive below 5°C.
Temperatures below this point will require adhesive to be warmed up to assist with adhesive flow and application.
Use only in ventilated areas.

Apply sealant to shower tray or bath first as shown in the right hand side diagram.

Ensure the protective film has been peeled back from tiling bead of base before applying sealant. Leave the rest of the shower tray or bath covered by the plastic film, to protect it during installation.

Apply a bead of sealant for 60mm from both front corners at base of upstand as shown.

Apply a second bead to full length at top of upstand.

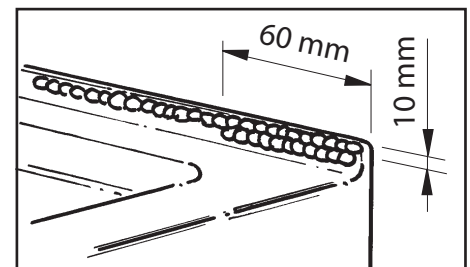

Apply adhesive to wall board.

Do not use on previously painted, sealed or ceramic walls.

Use only on the following substrate:

- Plaster Board
- Fibrecement
- Villaboard.

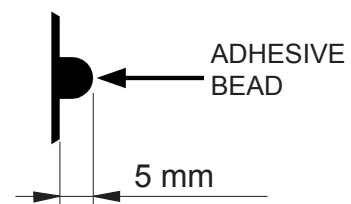

Follow the pattern marked. Start at top working your way down.

Apply vertical pattern first then fill in horizontal lines.

For corner contour shower walls remember to apply the adhesive on the acrylic wall as shown on previous page.



SHOWER WALL INSTALLATION cont...

Refer sealant and adhesive manufacturer instructions.

To install the wall follow the adhesive manufacturer's instructions.

As a general rule, place wall into position. Press firmly back into corner to ensure that the wall makes full contact with corner along its entire length.

Press into corners first, then press toward edges. Use a soft clean cloth to press firmly and remove any rippling along glue lines. Check and repress if necessary.

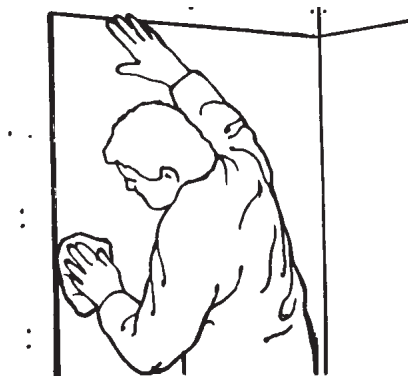

Remove plastic film.

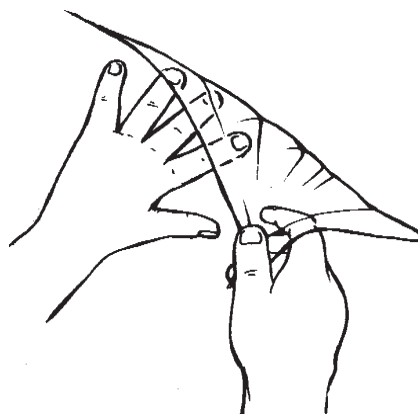

CLEANING INSTRUCTIONS

Use non-abrasive soap and warm water.

Avoid:

- harsh chemicals and disinfectants.
- abrasive cleaners
- solvent based cleaners
- acid or alkaline cleaners
- products containing ammonia or peroxides.

Wipe out the unit after each use to prevent build-up of soap and scum.

Always read the label instructions on any cleaner carefully before applying it to the surface.



IMPORTANT

Read the Care and Maintenance label on the wall and leave it in place for the end user.

CONTACT US FOR HELP

KOHLER Co.
PO Box 257
Regents Park
NSW 2143
Australia
Ph 1800 364 533
www.inglefield.com

